

PRODUCT SPECIFICATIONS

MODEL NO.	MOTOR	RPM		AMPS		HP	kW	NET WT.		CAPACITOR	
		60HZ	50HZ.	60HZ	50HZ			lbs.	kg	mfd.	VOLT
87R647-401-N470X	115-120/230-240 (60Hz) 110-120/220-240 (50Hz)	1725	1425	6.2/3.1	5.1/2.6	1/2	0.37	19.1	8.6	30	370

SOUND LEVEL LESS THAN 65 db(A)

NORMAL AMBIENT +5 °C - +40 °C

RELATIVE HUMIDITY 20% - 80%

ENVIRONMENT CLEAN DUST FREE

NOTES:

1. TECHNICAL DATA SUBJECT TO CHANGE WITHOUT NOTICE.
2. IF THE PUMP IS NOT INSTALLED IN AN INCLOSURE, A FAN COVER IS REQUIRED FOR SAFETY.
3. ALL DIMENSIONS ARE FOR REFERENCE ONLY.
4. KIT P/N: K964

PRODUCT PERFORMANCE: 50Hz CURVES BASED ON 230V.
60Hz CURVES BASED ON 115V.

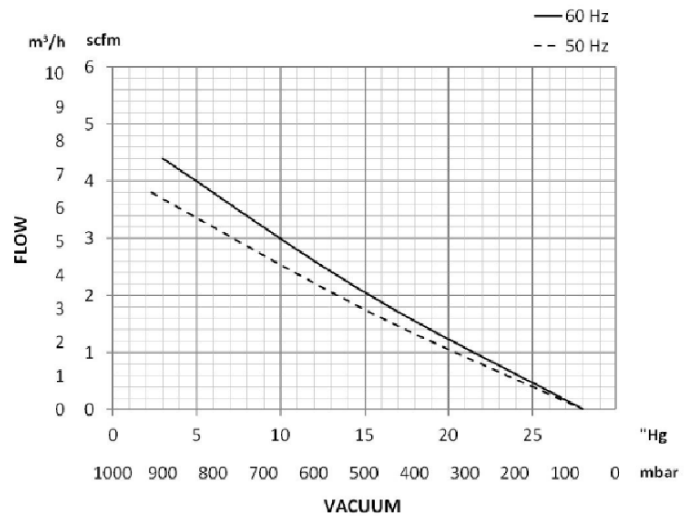
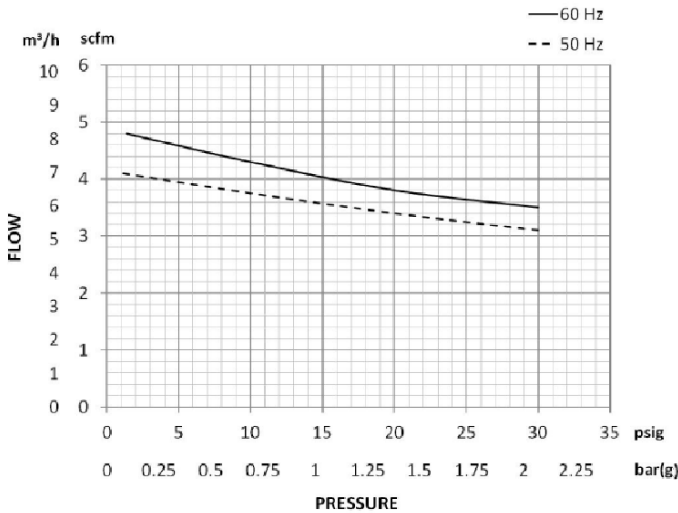

PRODUCT DIMENSIONS:

WIRING DIAGRAM

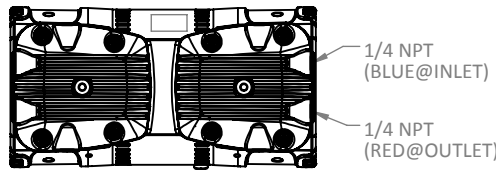
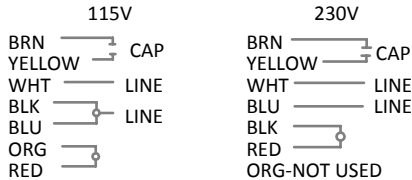

CAPACITOR MOUNTING KIT TO BE SHIPPED UNATTACHED.

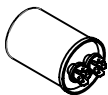
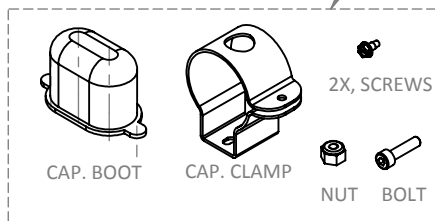

CAPACITOR TO BE SHIPPED UNATTACHED

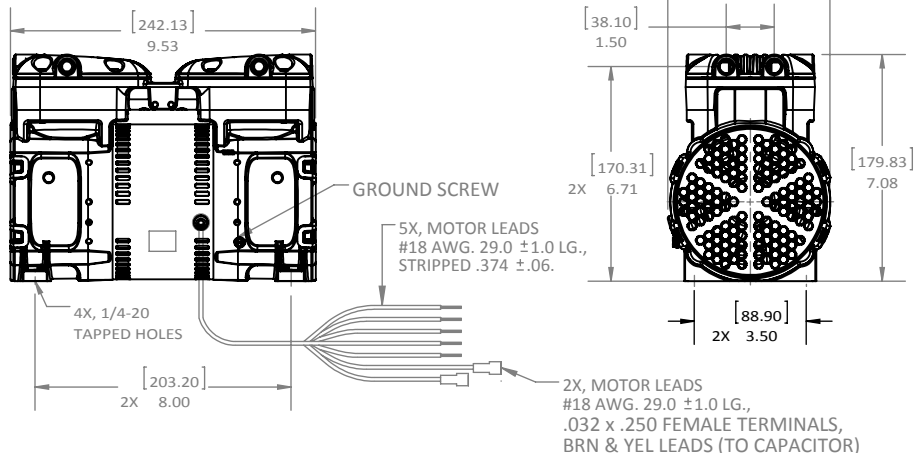

产品说明:

型号	电机电压	转速		电流		HP	kW	净重		电容	
		60HZ	50HZ	60HZ	50HZ			lbs.	kg	mfd.	VOLT
87R647-401-N470X	115-120/230-240 (60Hz) 110-120/220-240 (50Hz)	1725	1425	6.2/3.1	5.1/2.6	1/2	0.37	19.1	8.6	30	370

噪音: <65 db(A)

正常使用环境温度: +5 °C - +40 °C

相对湿度: 20% - 80%

环境: 无尘

产品性能: 50Hz 时, 电压 230V.
60Hz 时, 电压 115V.

备注:

1. 本技术参数表如有更新恕不通知;
2. 请将泵安装在一个外壳内, 否则出于安全考虑, 请安装风扇盖;
3. 所有尺寸仅供参考;
4. 维修包料号: K964。

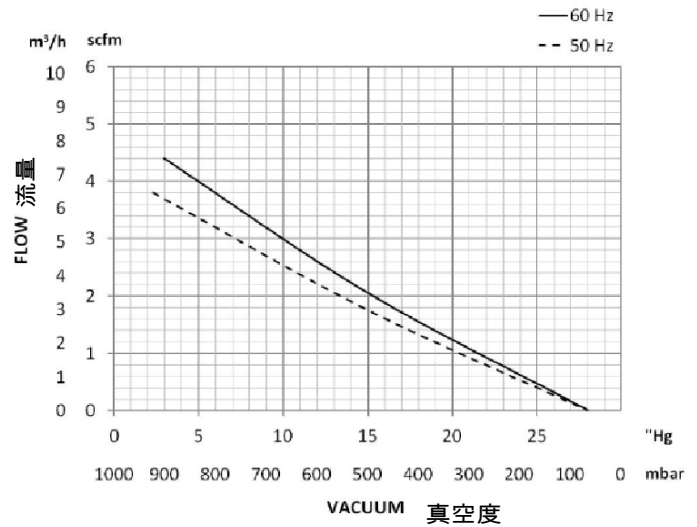
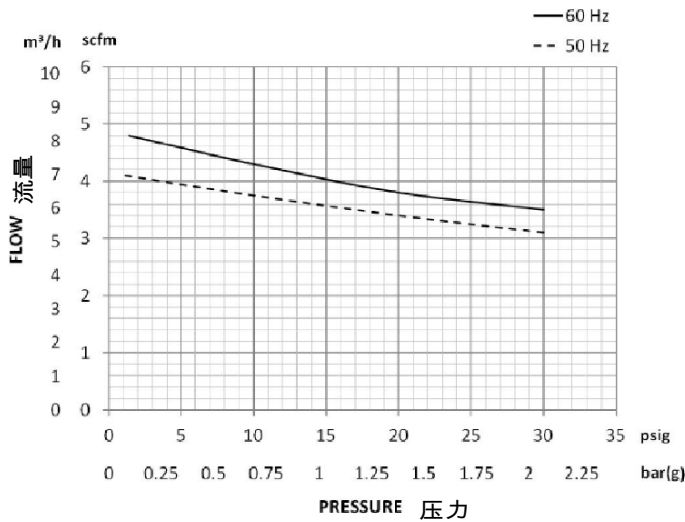

产品尺寸:

接线图

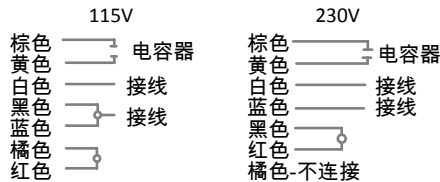

电容组件在发货时请不要安装

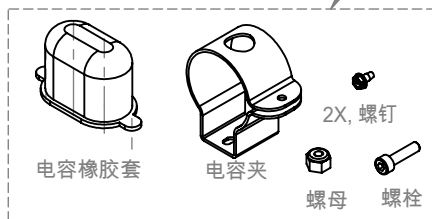

电容器在发货时请不要安装

